

# Blackline X12

## Compact Passive Two-Way System



### Features

- Compact passive two-way system
- Symmetrical multi-angle plywood enclosure
- User-rotatable 80° x 50° horn
- Vertical and horizontal orientation
- Screw-free, cloth-backed perforated steel grille
- Integral ergonomic handle
- Pole-mount bung maintains clean lines
- 8Ω nominal impedance
- Twin NL4 connectors
- Flexible mounting options via M8 inserts

### Applications

- Portable sound reinforcement
- Live music clubs
- Bars and restaurants
- Nightclubs
- Stage monitoring
- Corporate AV events and conferences
- Weddings and parties
- Main PA infill
- Secondary stages at festivals
- HoW, leisure centres and retail outlets



The X12 fulfils the requirement for a compact system that can deliver high sound levels — either as a stand-alone system or supplemented by a BlacklineX subwoofer. Featuring a 12" (300mm) LF driver unit and a 1" (25mm) exit compression driver on a user-rotatable horn, its 80° x 50° dispersion pattern is ideal for medium throw applications.

The LF driver has a 2.5" (63mm) voice coil and a high BL motor, while the HF compression driver utilises a 1.75" (44mm) polyimide diaphragm for extended high frequency response. Use with a BlacklineX Series subwoofer will enable the X12 to operate as a dancefloor or sound reinforcement system that is remarkably powerful for its size, as well as being extremely portable.

The X12 is constructed from plywood and fitted with a screw-free steel grille, M8 inserts for wall brackets and eyebolt suspension, plus a pole-mount socket with a removable bung that maintains clean lines in install applications. Finished in black textured paint as standard, the X12 can also be supplied in white or any RAL colour to order.

A full-range passive two-way system, the X12 may be used without a controller. However, the EQ and limiter functions of a controller such as the Martin Audio DX0.5 will maximise its capabilities. When used in conjunction with an X115, X118 or X210 subwoofer, crossover and EQ functions can be performed by the DX0.5, or by an MA Series amplifier with onboard DSP option.

Martin Audio Ltd  
Century Point, Halifax Road, High Wycombe  
Buckinghamshire HP12 3SL, England

Telephone: +44 (0) 1494 535 312  
Facsimile: +44 (0) 1494 438 669  
Email: [info@martin-audio.com](mailto:info@martin-audio.com)



# Blackline X12

## Compact Passive Two-Way System



### Technical Specifications

TYPE	Compact, passive two-way system
FREQUENCY RESPONSE (5)	62Hz-20kHz $\pm$ 3dB -10dB @ 50Hz
DRIVERS	LF: 12" (300mm)/2.5" (63.5mm) voice coil, ferrite motor system HF: 1" (25mm) exit/1.7" (44mm) voice coil, polyimide dome compression driver
RATED POWER (2)	300W AES, 1200W peak
RECOMMENDED AMPLIFIER	MA2.0, MA3.0, MA5.0Q
SENSITIVITY (8)	97dB
MAXIMUM SPL (9)	122dB continuous, 128dB peak
NOMINAL IMPEDANCE	8 ohms
DISPERSION (-6dB)	80° H x 50° V (user-rotatable)
CROSSOVER	2.3kHz passive
ENCLOSURE	Multi-angle birch/poplar ply
FINISH	Black textured paint
PROTECTIVE GRILLE	Black perforated steel with scrim cloth backing
CONNECTORS	2 x NL4 type
PIN CONNECTIONS (INPUT)	1+/-
PIN CONNECTIONS (LINK)	1+/- to 1+/-
FITTINGS	20 x M8 inserts, pole-mount socket, 1 x bar handle
DIMENSIONS	(W) 358mm x (H) 574mm x (D) 337mm (W) 14.1ins x (H) 22.6ins x (D) 13.7ins
WEIGHT	17kg (37.5lbs)
ACCESSORIES	Wall bracket, eyebolts

#### Notes

- (1) Measured on-axis in half (2pi) space at 2 metres, then referred to 1 metre.
- (2) AES Standard ANSI S4.26-1984.
- (3) Measured in half (2pi) space at 2 metres with 1 watt input, using band limited pink noise, then referred to 1 metre.
- (4) Measured in half (2pi) space at 2 metres using band limited pink noise, then referred to 1 metre.
- (5) Measured on-axis in open (4pi) space at 2 metres, then referred to 1 metre.
- (6) Measured in open (4pi) space at 2 metres with 1 watt input, using band limited pink noise, then referred to 1 metre.
- (7) Measured in open (4pi) space at 2 metres using band limited pink noise, then referred to 1 metre.
- (8) Measured in open (4pi) space at 2 metres with 2.83V input, using band limited pink noise, then referred to 1 metre.
- (9) Calculated at 1 metre.
- (10) Measured in half (2pi) space at 2 metres with 2.83V input, using band limited pink noise, then referred to 1 metre.

#### Trade Descriptions Act

Due to Martin Audio's policy of continuing improvement, we reserve the right to alter these specifications without prior notice. Martin Audio is committed to refining state of the art sound reinforcement, combining in-depth product and field applications research with advanced manufacturing techniques. Every Martin Audio product is built to the highest manufacturing standards and rigorously tested to ensure that it meets the performance criteria specified in the design.

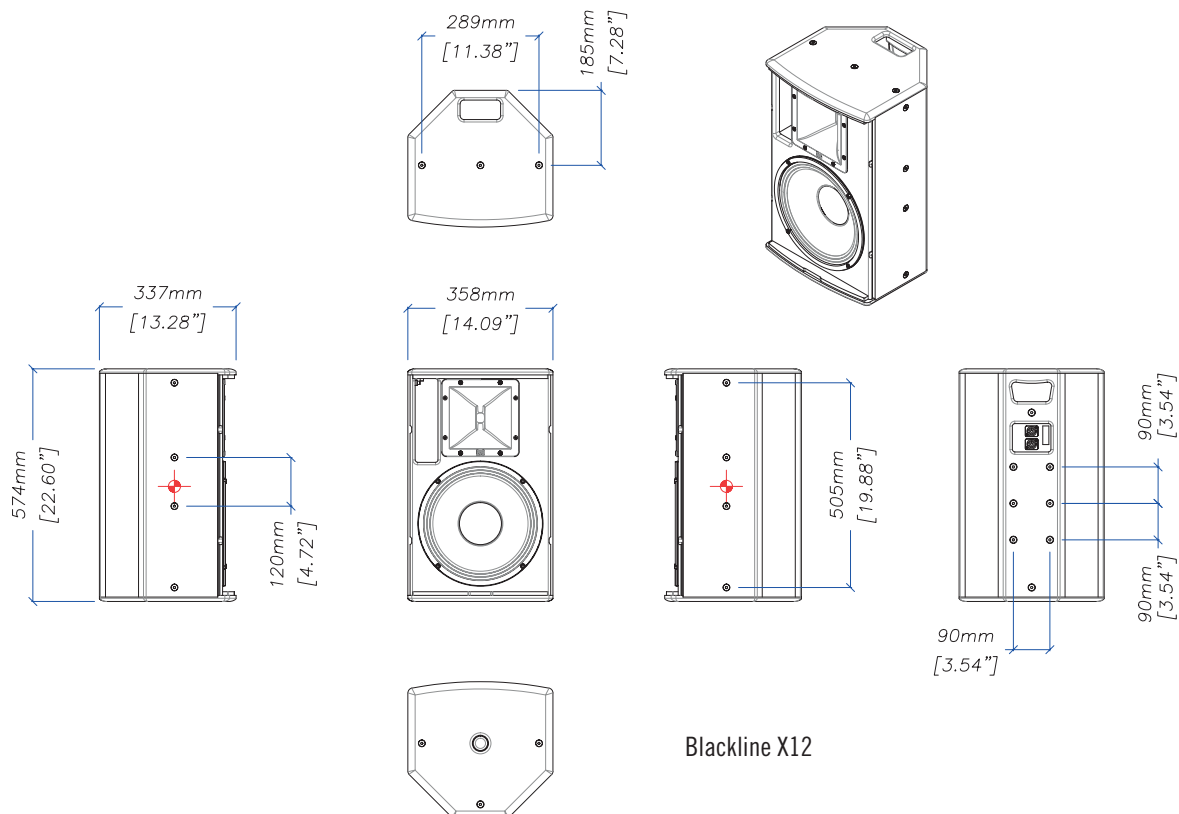

Blackline X12

Martin Audio Ltd  
Century Point, Halifax Road, High Wycombe  
Buckinghamshire HP12 3SL, England

Telephone: +44 (0) 1494 535 312  
Facsimile: +44 (0) 1494 438 669  
Email: [info@martin-audio.com](mailto:info@martin-audio.com)

All information is Copyright © 2017 Martin Audio Ltd.



[www.martin-audio.com](http://www.martin-audio.com)